

# ATS320 AC ATS CONTROLLER USER MANUAL V 1.0

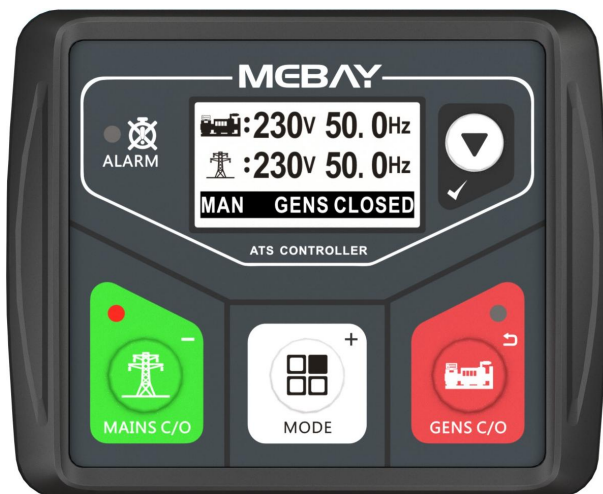

## Software Version

No.	Version	Date	Note
1	V1.0	2021-06-01	Original release.



Chongqing Mebay Technology Co.,Ltd

Add: No6-2,Building 4, Gangan Rd, Jiangbei District, Chongqing.

Tel: +86-23-6869 3061



Fax: +86-23-6765 8207

Web: <http://www.mebay.cn>

<http://www.cqmb.cn>

E\_mail: [sales@mebay.cn](mailto:sales@mebay.cn)

Symbol Description

Symbol	Description
 Note	Remind operators to operate correctly, otherwise it may cause the equipment not to work correctly.
 Be care	It is indicated that potential hazards can damage equipment without proper precautions.
 Warning	It is indicated if appropriate preventive measures are not taken, potentially dangerous situations may result in death, serious personal injury or significant property losses.

**Warning**

- 1.The installation of this equipment must be carried out by professionals.
- 2.When installing and operating the controller, please read the entire instruction manual first.
- 3.Any maintenance and commissioning of the equipment must be familiar with all the equipment.
- 4.Safety standards and precautions in advance, otherwise it may cause personal injury or damage to related equipment.
- 5.After the installation of the controller is completed, please verify that all protection functions are valid.

**Be Care**

- 1.Please keep the good connection of the power supply of the controller. Do not share the connection lines of the positive and negative electrodes of the battery with the floating charger.
- 2.During the operation of the engine, do not disconnect the battery, otherwise it may cause damage to the controller.

## Catalogue

Summary.....	6
Main Features.....	6
Parameters Display.....	6
Parameters.....	7
Overall Dimension and Wiring Diagram.....	7
Installation instruction.....	10
Panel and display.....	10
Control and operating instructions.....	12
Prompt status information.....	13
Warning and fault alarm.....	14
Parameter setting.....	15
Fault finding.....	17

### Notes:

1. All rights reserved. No part of this duplication may be reproduced in any material form (including photocopying or storing in any medium by electronic means or others) without the written permission of the copyright holder.
2. MEBAY Technology reserves the rights to change the contents of this document without prior notice.

## Summary

The controller is a mains/gens ATS controller, which can automatically or manually control the ATS dual power switch, suitable for the application of one mains and one power generation. The LCD screen can display various faults at the same time. Once the generator does not run normally, it can effectively achieve protection. It can display single-phase power generation voltage, power generation frequency, mains voltage, and mains frequency; the working mode (manual, automatic, test, shutdown) indicates the working status of the ATS switch through the LED indicator;

There are Chinese/English interface options, more language can be set according to user's request. All the parameters can be configured through the front face buttons or use programmable interface by USB to adjust via PC. It has compact structure, advanced circuits, simple wiring and high reliability, It can be widely used in various types of power systems.

## Main Features

- ◆ Dual core 32bit high performance single chip microcomputer.
- ◆ LCD screen, Available in Chinese/English languages, user's language set if necessary.
- ◆ Collection and display, gen, mains, phase and other parameters.
- ◆ Automatic/Manual mode. In manual mode, can force the switch to close or open.
- ◆ Suitable for various AC systems (3 phase 4-wires., single-phase 2-wire, and 2-phase 3-wire).
- ◆ Input/output function, status can be shown directly.
- ◆ Totally 3 relays output.
- ◆ Totally 2 configurable switch input.
- ◆ USB Port: parameters can be set even without power through USD port to monitor in real time.
- ◆ Control Protection: Realize automatic ATS switching of generator sets, perfect fault display and protection functions.
- ◆ Standard water-proof rubber gasket. The waterproof can reach IP54.
- ◆ Module design: All the connections are adapted with European connectors so that installation, connection, repair and replacement can be more easily.

## Parameters Display

- ◆ Mains voltage
- ◆ Mains Frequency
- ◆ Gens Voltage
- ◆ Gens Frequency
- ◆ Switch Status
- ◆ Work Mode
- ◆ Total Running Time
- ◆ Total Working time
- ◆ Real-time status

**Parameters**

Options	Parameters
Working voltage	AC 90V-450V(L1N1/L2N2)
Power consumption	Standby: MAX 1W
	Working: MAX 2W
Gens Voltage Input	1P2W 90VAC-450VAC (ph-N)
Mains Voltage Input	1P2W 90VAC-450VAC (ph-N)
MAX Accumulating Time	99999.9Hours (Min Store time:6min)
Closing gens output	250V/5 AMP Non-contact normally Open output
Closing mains output	250V/5 AMP Non-contact normally Open output
Remote start output	250V/3 AMP Non-contact normally close output
Closing Gens input	Engagement brake feedback signal valid
Closing Mains input	
Working condition	-25-70°C
Storage condition	-40-80°C
Protection Level	IP54: when waterproof rubber gasket is added between controller and its panel
Overall dimension	106mm*86mm*45mm
Panel cutout	78mm*66mm
Weight	0.5Kg

**Overall Dimension and Wiring Diagram**
**◆ Overall Dimension:**

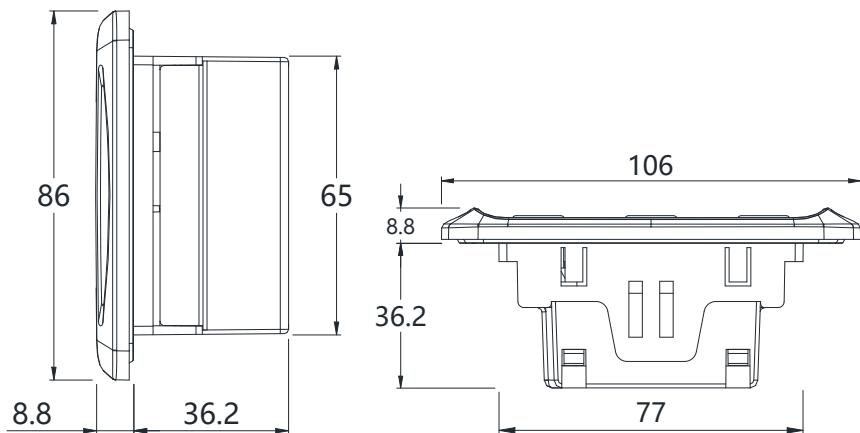
◆ Descriptions of terminal connection

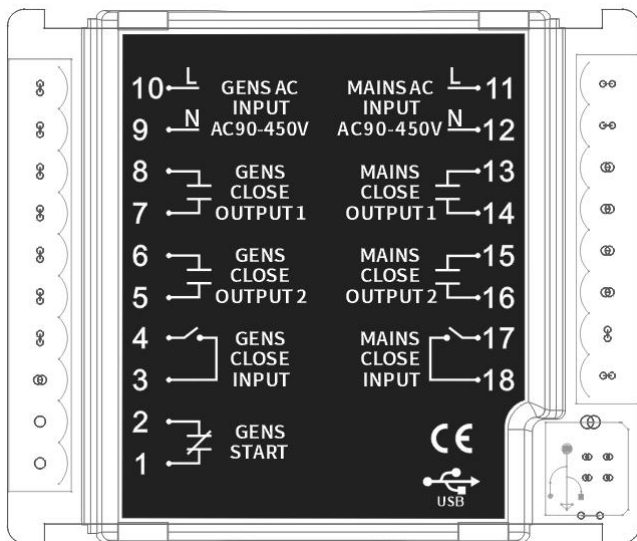

No.	Function	Description	Cable cross sectional area
1	Gens remote start	Non-contact normally close output	1.0mm <sup>2</sup>
2		Capacity: 250V/3A	1.0mm <sup>2</sup>
3	Gens closing feedback input	Engagement brake feedback signal	1.0mm <sup>2</sup>
4			1.0mm <sup>2</sup>
5	Gens close output 2A	Non-contact normally close output Capacity: 250V/5A Gens closing output 2 and Gens	1.0mm <sup>2</sup>
6	Gens close output 2B		1.0mm <sup>2</sup>



		closing output 1 act at the same time.	
7	Gens close output 1A	Non-contact normally close output Capacity: 250V/5A Gens closing output 1 and Gens closing output 2 act at the same time.	1.0mm <sup>2</sup>
8	Gens close output 1B		1.0mm <sup>2</sup>
9	Gens AC input N	Gens AC input 90-450V	1.0mm <sup>2</sup>
10	Gens AC input L		1.0mm <sup>2</sup>
11	Mains AC input L	Mains AC input 90-450V	1.0mm <sup>2</sup>
12	Mains AC input N		1.0mm <sup>2</sup>
13	mains close output 1A	Non-contact normally close output Capacity: 250V/5A mains closing output 1 and mains closing output 2 act at the same time.	1.0mm <sup>2</sup>
14	Mains close output 1B		1.0mm <sup>2</sup>
15	Mains close output 2A	Non-contact normally close output Capacity: 250V/5A mains closing output 2 and mains closing output 1 act at the same time.	1.0mm <sup>2</sup>
16	Mains close output 2B		1.0mm <sup>2</sup>
17	Mains closing	Engagement brake feedback signal	1.0mm <sup>2</sup>
18	feedback input		1.0mm <sup>2</sup>
	USB-B	For PC operation and control	

◆ **ATS320 AC Typical Wiring Diagram**

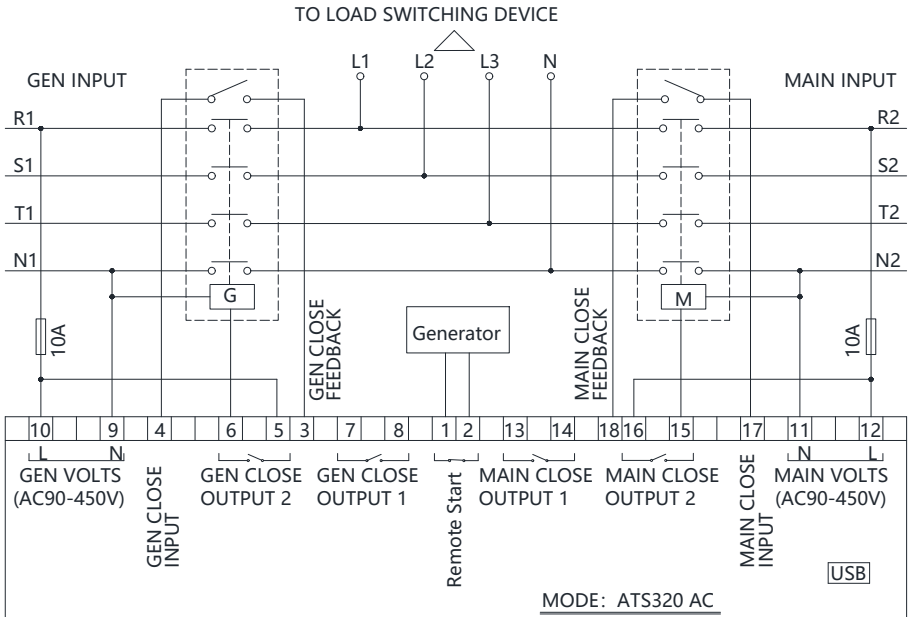

**Installation instruction**

- ◆ The controller is fixed by two special fixing members and screws, and the screws of the metal fasteners cannot be too tight.
- ◆ Panel Cutout: W78mm\*H66mm.



**Note:** If the controller is installed directly in the genset shell or other fluctuated equipment, the rubber pad must be installed.

**Panel and display**

◆ **ATS320 AC**

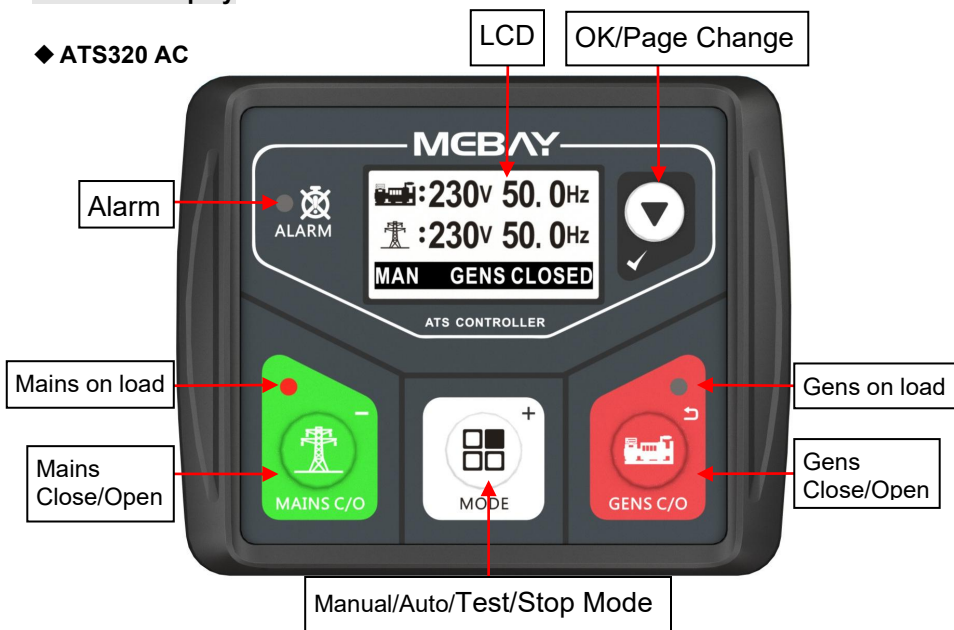

◆ **LED Indicators description**

Indicator Type	Description
Alarm	◆ Lights red when a fault alarm occurs.
Mains on load	◆ It is light on when mains close input is activated.
Gens on load	◆ It is light on when gens close input is activated.

Input /Output Description	Description
I1	◆ Mans closed
I2	◆ Gens closed
O1	◆ Remote start output
O2	◆ Gens output
O3	◆ Mans output











### ◆ Key Function Description

KEYS	NAME	Main Function
	Mains Close/Open Decrease	<ul style="list-style-type: none"> <li>◆ Active in Manual mode. Press this key, mains closing forced output or mains open.</li> <li>◆ Under edition mode, to decrease the numbers.</li> <li>◆ Under records mode, pressing this key to change the page.</li> </ul>
	Manual Mode Auto Mode Test Mode Stop Mode Increase Manual start/ stop	<ul style="list-style-type: none"> <li>◆ Pressing this key will set the module into Manual Mode/Auto Mode/Test Mode/Stop Mode.</li> <li>◆ Under edition mode, to increase the numbers.</li> <li>◆ Under records mode, pressing this key to change the page.</li> <li>◆ In manual mode, press this button for 3s to enter manual start and stop;</li> </ul>
	Gens Close/Open Revert	<ul style="list-style-type: none"> <li>◆ Active in Manual mode. Press this key, gens closing forced output or gens open.</li> <li>◆ Pressing this key can cancel the setting and back to upper class under edition.</li> <li>◆ Under the setting mode with checking data, the data can be saved and system will exit after pressing.</li> </ul>
	Page change OK Setting mode	<ul style="list-style-type: none"> <li>◆ Page change.</li> <li>◆ Confirm the change under edition mode.</li> <li>◆ Choose alarm records under records checking mode.</li> <li>◆ Press for 3 seconds to enter the parameter setting mode.</li> </ul>

### ◆ Alarm records checking

ATS 320 controller can save 12 group of alarm records which contains the alarm record data includes detailed data such as alarm time, prompt status information, etc. How to check the alarm records:

1. Enter alarm record page: Enter the setting mode, select the alarm record and press  key to enter
2. Press  to turn upper digit and press  to turn lower digit in order to choose the record you need. Press  to confirm the record and come into history records checking page.
3. Press  to turn lower records under records checking page. Press  to turn upper records and press  to revert back to alarm history records page.
4. Exit from records page: In the history records page and checking page, press  to exit.

### Control and operating instructions

The controller can work in manual mode, automatic mode, test mode, stop mode, and switch by pressing the  key. When the mode is valid, the mode and status are displayed in the status bar.



 Remote start output is default set as Genset Start Output (Normally Open) and there is only normally close contact in it. The controller also can control the genset start even if there is no power supply.

### Test Mode

When  switches to the test mode for 5S, it will automatically enter the load test machine: the generator start signal will be output immediately. After the power generation voltage is normal, the load will switch to power generation regardless of whether the mains voltage is normal or not.

### Manual Mode and Manual start/ stop

When the button  status bar shows manual mode, it means that the controller is working in manual mode.

In manual mode, when the  key is pressed, the mains closing output relay will be forcibly output; when the  key is pressed, the power generation closing output relay will be forcibly output. In manual mode, the generator set start relay does not output.

In manual mode, press and hold the MODE button  for more than 3 seconds, and you will directly enter the manual start-up interface as follows. Press the MODE key

- again to cycle through different parameter rows, and then press the confirm key  
 to confirm the operation.

<b>1.Return</b>	
2.Stop Genset	Disconnect the start signal, i.e. stop the running genset.
3.Start Genset	Output the start signal, i.e. start the genset.

### Manual Mode

In AUTO mode: When the mains changes from normal to abnormal (loss, overvoltage, undervoltage), the [mains abnormal delay] will start immediately. When the delay is completed, the mains is still in an abnormal state, then start [Generator Start Delay]. When the delay is over, the generator start output relay is closed to control the start of the generator set. When the voltage of the generator set is normal, it will start [Gens Normal Delay], after the [Transition Interval Delay], the generator closing output relay will be closed, and the ATS switch to the generator group for power supply.

When the mains changes from abnormal to normal, the [mains normal delay] will start immediately. After the delay is over, the generator closing relay will be disconnected. After the [transition interval delay], the mains closing output relay is closed, and the ATS switch to mains power supply.

When the mains power returns to normal, immediately start [Gen Shutdown Delay]. After the delay is over, the output relay of the generator start-up is disconnected to control the generator set to stop;

### Stop mode:

When switching to the stop mode, the generator start signal is immediately turned off. In this mode, warnings and alarms are invalid. Except for the screen change key, all other keys on the panel are invalid.

When performing equipment maintenance, please make sure that the controller is working in manual mode. Check and confirm the position of the ATS switch to prevent accidents and endanger personal safety.

### Prompt status information

NO.	Item	Description
1	G. closed	The gens has been closed,show in status bar.
2	M. closed	The mains has been closed,show in status bar.
3	Offload	Switch was already opened and load disconnect.
4	Remote Start	When the remote start output is valid. Show in status bar
5	Alarming	When there is fault alarm occurs, the indication will be displayed when change the genset mode to Auto Mode manually. Show in status bar
6	AUTO	Current mode is Auto mode. Show in status bar

7	MAN	Current mode is Manual mode. Show in status bar
8	STOP	Current mode is Stop mode. Show in status bar
9	TEST	Current mode is Test mode. Show in status bar

**Gens/Mains Voltage status**

No.	Item	Description
1	Gens start	Delay time before genset start
2	Gens return	Delay time before genset stop
3	Gens working	Genset start signal output.
4	Gens standby	There is no start genset signal output.
5	M available	Mains normal Delay.
6	M unavailable	Mains abnormal Delay.
7	G available	Gens normal Delay.
8	G unavailable	Gens abnormal Delay.

**Switch status**

No.	Item	Description
1	Closing gens	Genset closing delay is in progress.
2	Closing mains	Mains closing delay is in progress.
3	Transfer rest	Interval time between switch transfer
4	Gens on load	Genset was already closed and gens is taking load.
5	Mains on load	Mains was already closed and mains is taking load.
6	Offload	Switch was already opened and load disconnect.

**Warning and fault alarm**
**◆ fault alarm**

Warning: After the fault alarm occurs, the system will be immediately trip. Only after troubleshooting, can it be closing normally.



Notes: When a fault alarm occurs, the "**ALARM**" lights flicker and the current fault interface displays the alarm description and trips.

NO.	Item	Description
1	G fail to close	In Auto mode, Gens close failure is occurs. " <b>ALARM</b> " lights always on, displays " <b>G fail to close</b> " on the current fault screen.
2	M fail to close	In Auto mode, Mains close failure is occurs. " <b>ALARM</b> " lights always on, displays " <b>M fail to close</b> " on the current fault screen.
3	Gens over volt	The gens voltage is greater than its set upper limit. " <b>ALARM</b> " lights always on, displays " <b>Gens over volt</b> " on the current fault screen.
4	Gens under volt	The gens voltage is less than its set lower limit. " <b>ALARM</b> " lights always on, displays " <b>Gens over volt</b> " on the current fault screen.
5	Gens over freq	The gens frequency is greater than its set upper limit. " <b>ALARM</b> " lights always on, displays " <b>Gens over freq</b> " on the current fault screen.
6	Gens under freq	The gens frequency is less than its set lower limit. " <b>ALARM</b> " lights always on, displays " <b>Gens under freq</b> " on the current fault screen.

## Parameter setting

### ◆ Enter the edition page

Please set the parameters according to below steps:

- 1) Press the key for 3 seconds to enter the parameter setting interface;
- 2) Under the parameter browsing interface, press to shift up the parameters, press to shift down the parameters, press to get into parameter changing page. The default password is “07623” .
- 3) Under the parameter browsing interface, press to shift up the parameters, press to shift down the parameters, press to get into parameter changing page.
- 4) Under the parameter modification interface, Press to add number 1, press to reduce number 1, press to turn the digit into right and done.
- 5) After the parameter modification is completed, press the key to confirm the modification, the item identifier stops flashing , indicating that it returns to the parameter browsing interface;
- 6) Under the parameter modification interface, Press to cancel parameter modification and return to parameter browsing interface.
- 7) Under the parameter browsing interface, Press to save the parameters and exit from edition page.

Revert back to default: put password "97011" when coming into parameters setting, then all the parameters can be set as defaults.

Note: the data can't be saved if the user didn't press to confirm the setting.

Warning: The parameter setting will take effect immediately after the completion, please pay attention to site safety!

### ◆ Parameter list.

#### 1) Basic setting

No	Parameter	Range (default)	Notes
0	Language	0-English 1-简体中文 2-繁體中文	Language option.
1	Mains available delay	1.0-999.0S(10.0S)	The delay from mains voltage abnormal to normal.
2	Mains unavailable delay	1.0-999.0S(5.0S)	The delay from mains voltage normal to abnormal.
3	Gens available delay	1.0-999.0S(10.0S)	The delay from gens voltage abnormal to normal.
4	Gens unavailable delay	1.0-999.0S(5.0S)	The delay from gens voltage normal to abnormal.
5	Gen start delay	0-9999.0S(1.0S)	When the genset is ready to start, start delay begins, after the start delay has expired, start signal will be initiated.

6	Gen stop delay	0-9999.0S( <b>5.0S</b> )	When the genset is ready to stop, stop delay begins, after the stop delay has expired, stop signal will be initiated.
7	Load /Unload pulse width	1.0-60.0s( <b>10.0s</b> )	Mains and Gens loading and unloading pulse width, when it is 60s, it is regarded as continuous output.
8	Transfer Interval	0-999.0( <b>1.0S</b> )	Interval time from mains switch open to gens switch close; or from gens switch open to mains switch close.
9	Over conversion delay	0-20.0s( <b>20.0s</b> )	Under the condition of continuous output of closing and opening: the time that the closing relay continues to output after detecting the closing state signal.
10	Mains under volt	55-330V( <b>184V</b> )	When the mains voltage is lower than the "low voltage crank threshold" and comes into mains low voltage delay(normal failure delay) but still lower, then mains becomes invalid. If the voltage become higher than "low voltage revert threshold" during normal failure delay time, then it will not alarm.
11	Revert under volt	55-330V( <b>207V</b> )	When the mains voltage is higher than the "high voltage crank threshold" and comes into mains high voltage delay(normal failure delay) but still higher, then mains becomes invalid. If the voltage become lower than "low voltage revert threshold" during normal failure delay time, then it will not alarm.
12	Mains over volt	55-500V( <b>276V</b> )	Generator over frequency value, when the generator frequency is higher than this value, it is considered that the generating frequency is abnormal. The maximum value disables this alarm.
13	Revert over volt	55-500V( <b>253V</b> )	Generator under-frequency value. When the generator frequency is lower than this value, the generator frequency is considered abnormal. The minimum value disables this alarm.
14	Gens over freq alarm	40-80.0HZ( <b>57.0HZ</b> )	The generator overvoltage value. When the generator voltage is higher than this value, the generator voltage is considered abnormal. The maximum value disables this alarm.
15	Gens under freq alarm	0-70.0HZ( <b>40.0HZ</b> )	Generator undervoltage value. When the generator voltage is lower than this value, the generator voltage is considered abnormal. The minimum value disables this alarm.
16	Gens over voltage alarm	0-360V( <b>264V</b> )	When the closing status input is enabled: the status of the closing status indicator on the panel will be indicated according to the input status. Otherwise, it will be generated by the action of the mains or power generation
17	Gens under voltage alarm	0-360V( <b>192V</b> )	
18	Closed state input	0:Disable 1: <b>Enable</b>	



			closing relay.
19	Gens AC system	0: Single Phase,2-Wire 1: 2-Phase,3-Wire <b>3: 3-Phase,4-Wire</b>	AC power supply mode for closing output.
20	Mains AC system	0: Single Phase,2-Wire 1: 2-Phase,3-Wire <b>3: 3-Phase,4-Wire</b>	AC power supply mode for closing output.
21	Primary Modes	0: Manual 1: Auto <b>2: Previous Mode</b>	The primary modes on power, easy for user operation.
22	User password	00000-65535 <b>(07623)</b>	Change the password.
23	Start screen display	0-20.0s <b>(5.0s)</b>	Start screen display time,0: No-display.
24	Saving mode	5.0-6000.0s <b>(600.0s)</b>	LCD light will be closed automatically without any button pressed after delay. If setting as 6000.0s, back light always lighted.
25	Homing display	5.0-600.0s <b>(600.0s)</b>	The time when the page reverts back to the home page, If setting as 600.0s: disabled.
26	LOGO delay display under standby	5.0-6000.0 <b>(6000.0s)</b>	Start screen will be opened without any button pressed after delay, If setting as 6000.0s: disabled.
27	LCD contrast	10-60 <b>(35)</b>	Set the LCD display contrast.
28	TEST mode	<b>0:Disable</b> 1:Enable	Set whether the controller test file function is enabled.
29	Manual gear close/open	0: Disable <b>1: Enable</b>	When the controller is in manual gear, set whether to switch on or off by pressing the button.
30	Lock automatic gear	<b>0:Disable</b> 1:Enable	Locked in automatic gear after activation.

### Fault finding

Symptoms	Possible Solutions
Controller no response with power	Check mains or gens AC power supply.
Genset Start Abnormal	Check the connection line between the controller and the generator set self-starting control interface; Check whether the remote start function setting is normal; Check that the related delay setting of the controller is normal.
ATS not transfer	Check the ATS switch; Check the connection line between the controller and ATS; Check the controller delay and other parameter settings.